

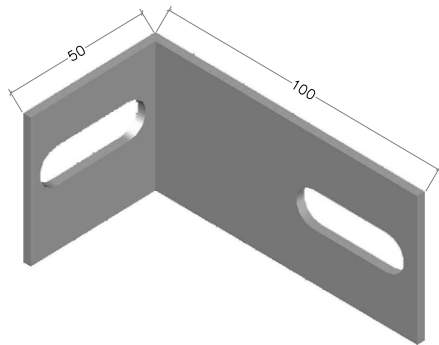

code	profile	profile features	code	profile	profile features
------	---------	------------------	------	---------	------------------

SPECIAL STEEL BRACKET



H BODY ANCHOR

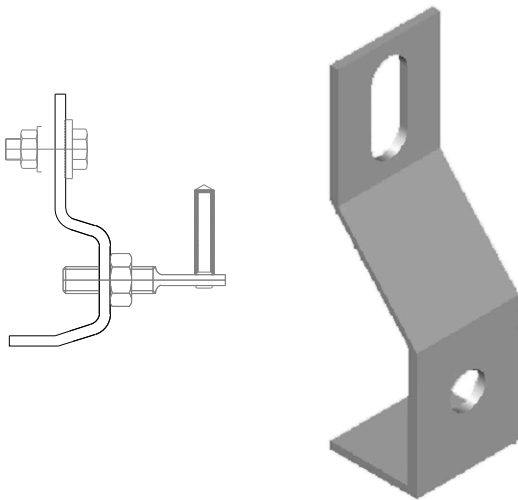

VERTICAL PROFILE

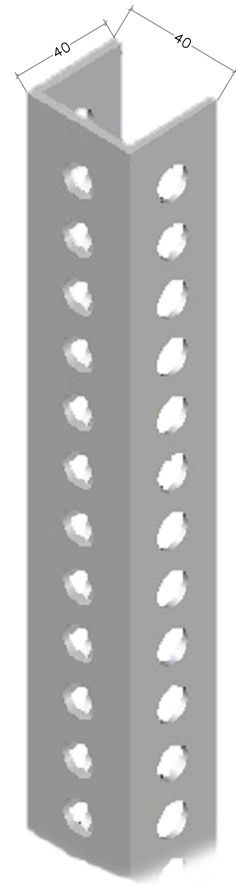

BOLT

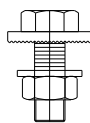

5mm PIN

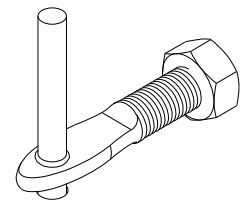
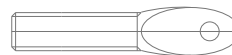

Steel Dowel

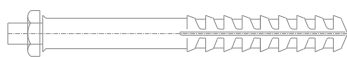

Plastic Dowel

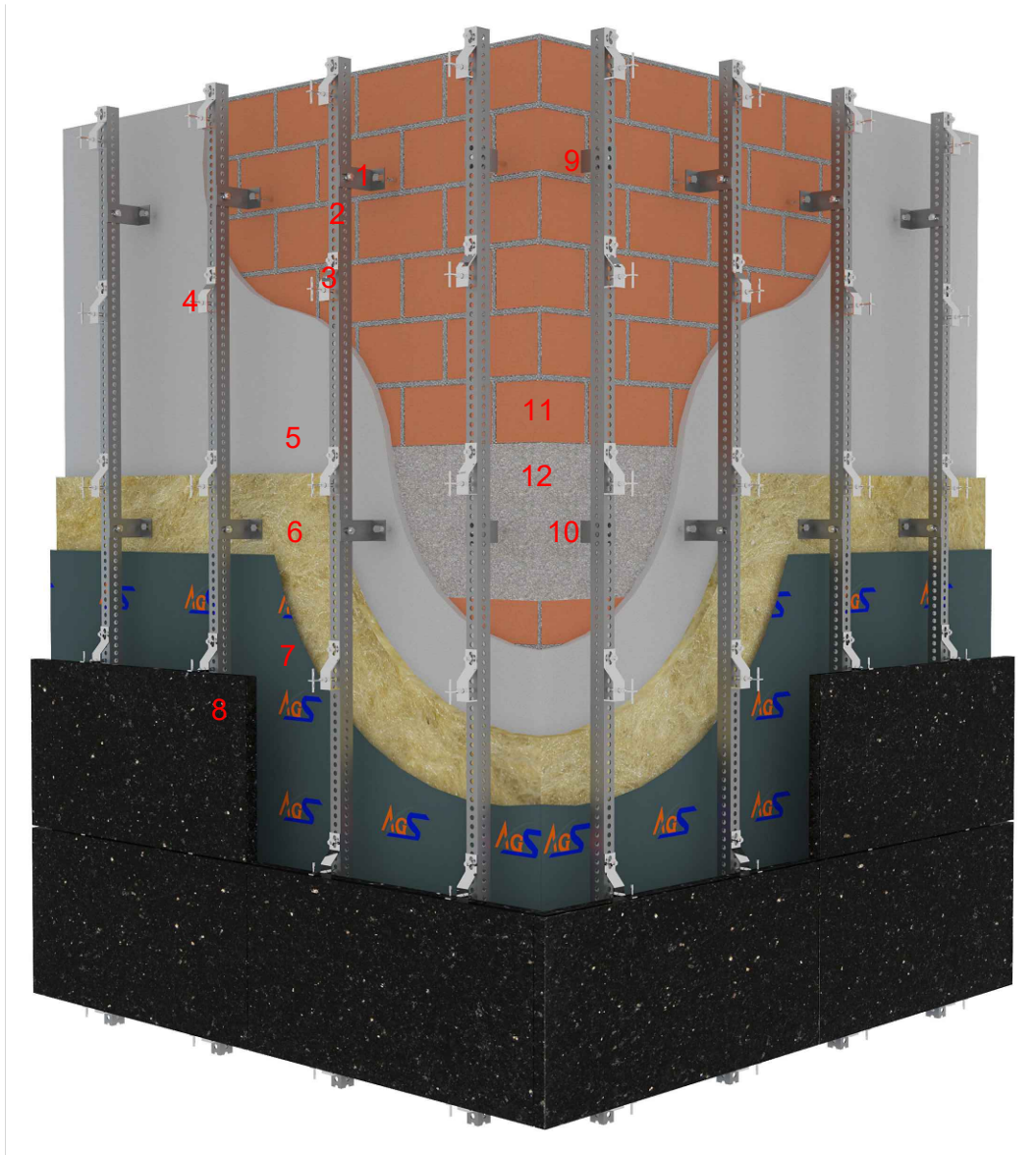

1. SPECIAL STEEL BRACKET
2. VERTICAL PROFILE
3. H BODY ANCHOR
4. PIN 5mm
5. PLASTER
6. THERMAL INSULATION
7. WATERPROOF MEMBRANE
8. NATURAL STONE
9. PLASTIC DOWEL
10. STEEL DOWEL
11. BRICK BLOCK
12. CONCRETE BEAM

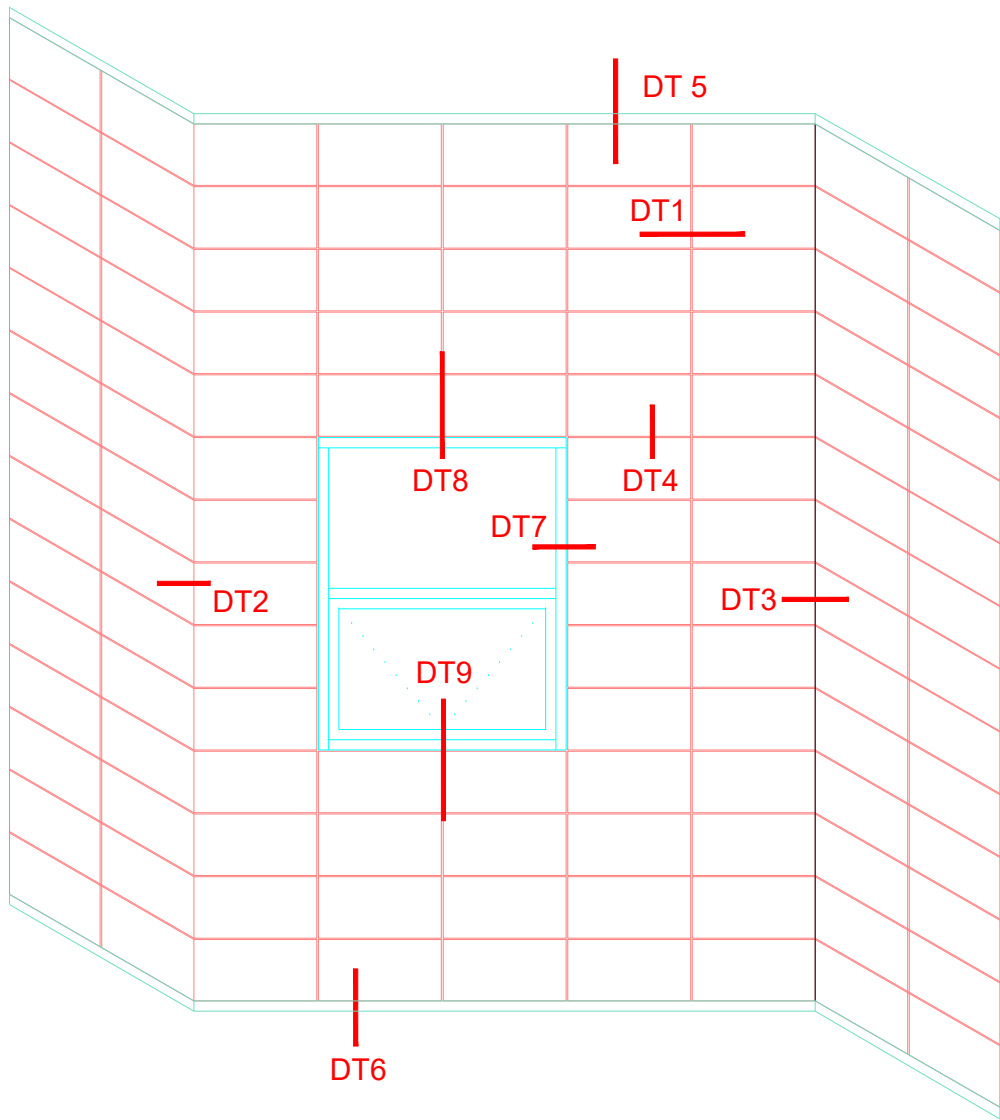

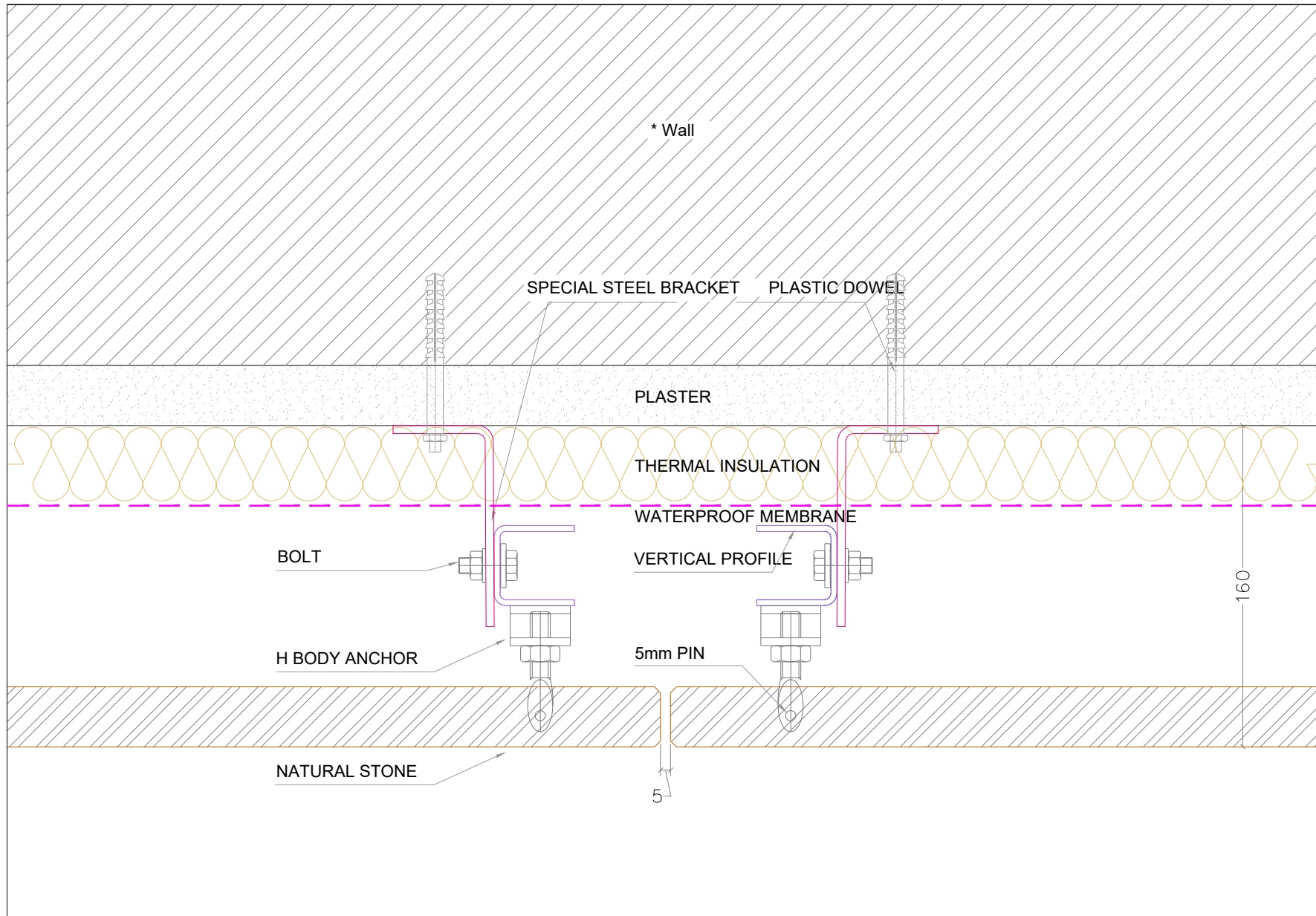

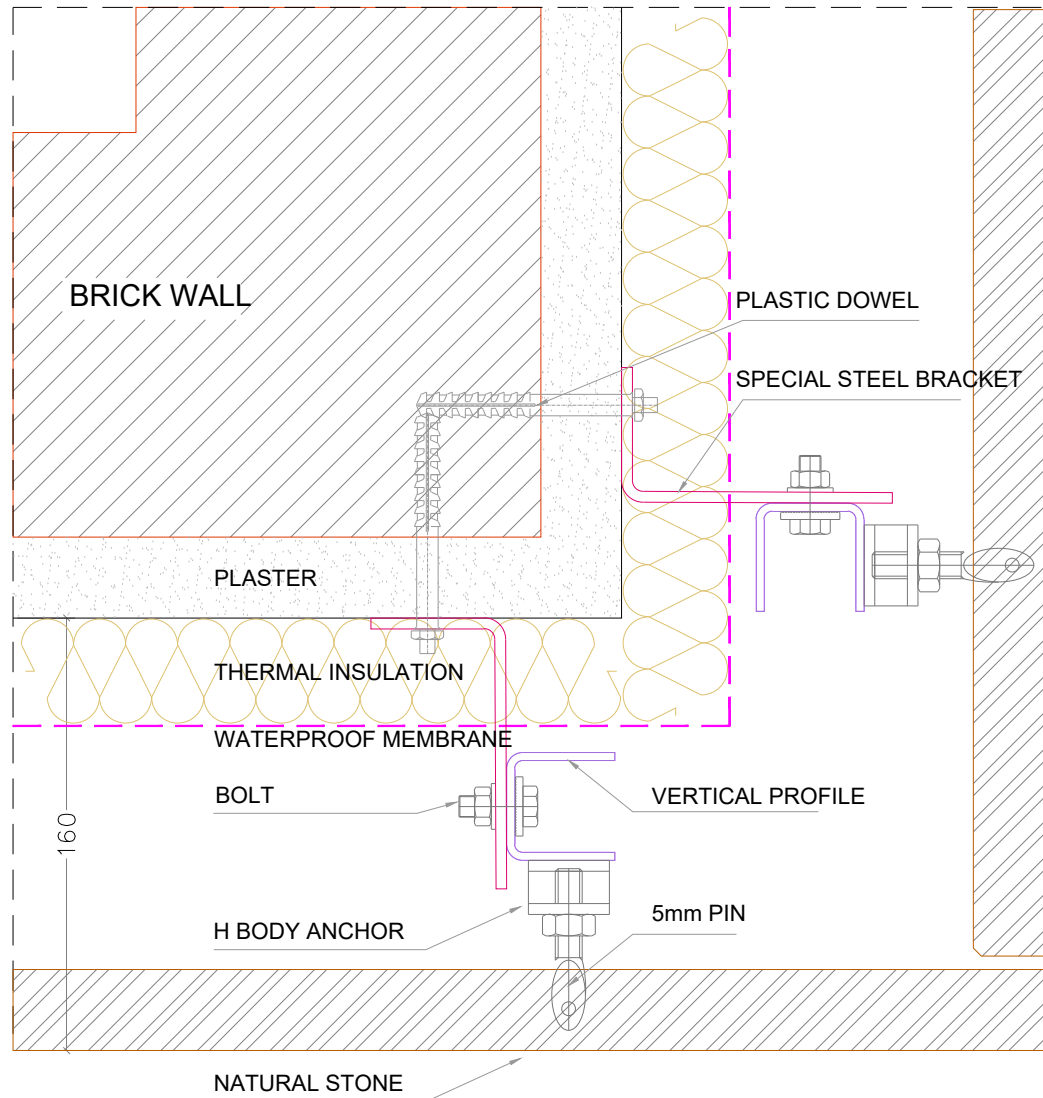

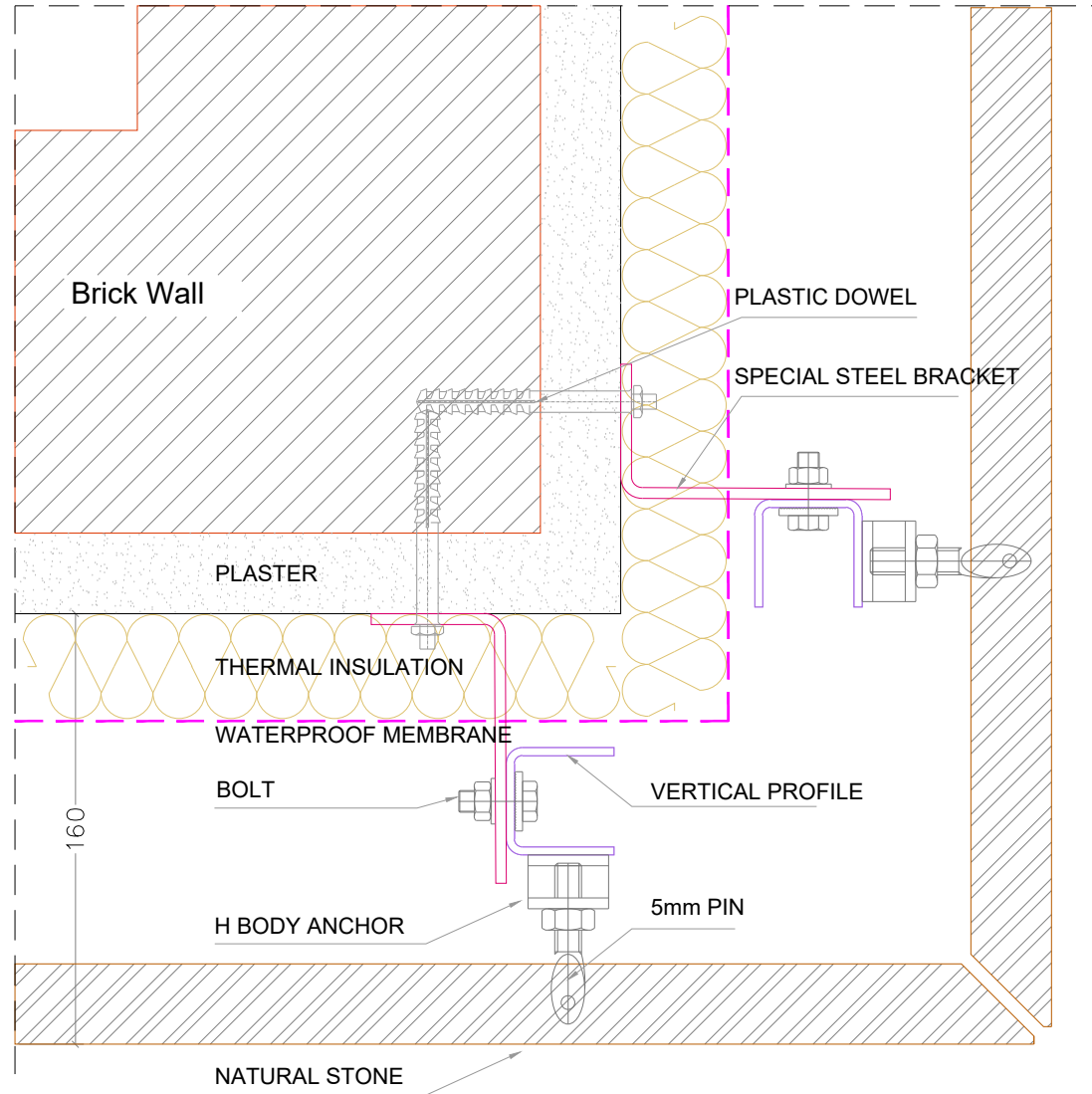

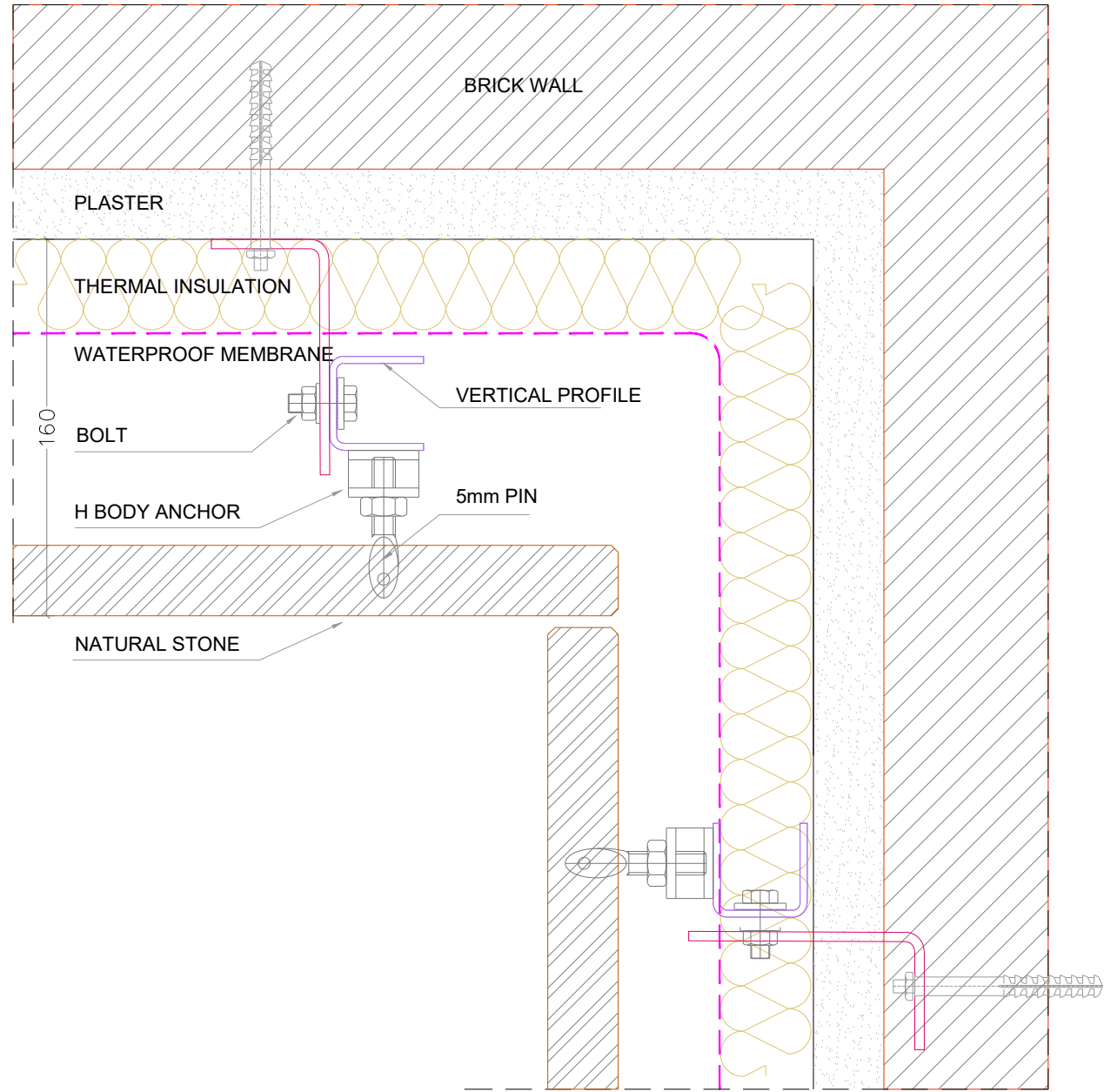

DETAIL 3

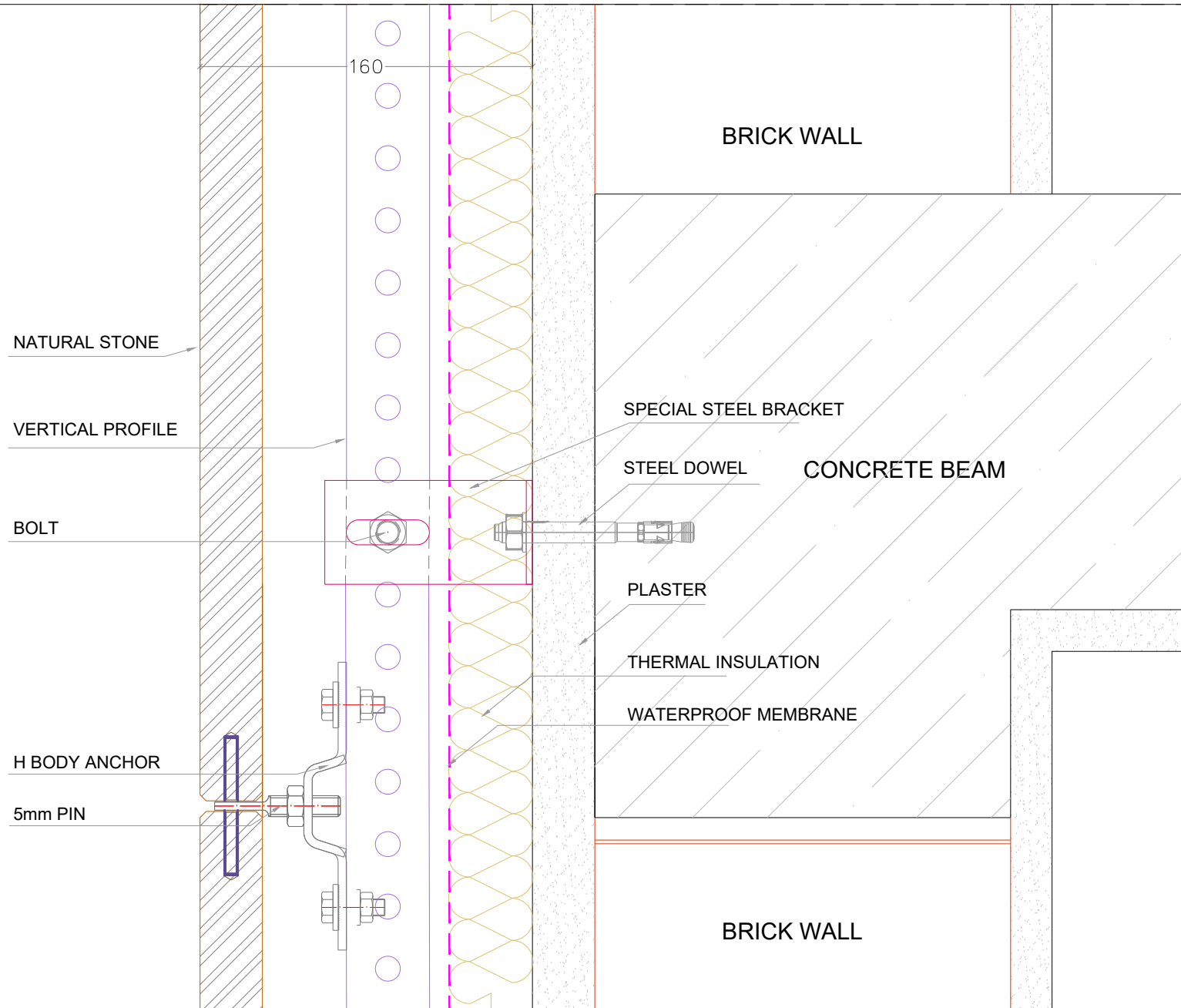

DETAIL 4

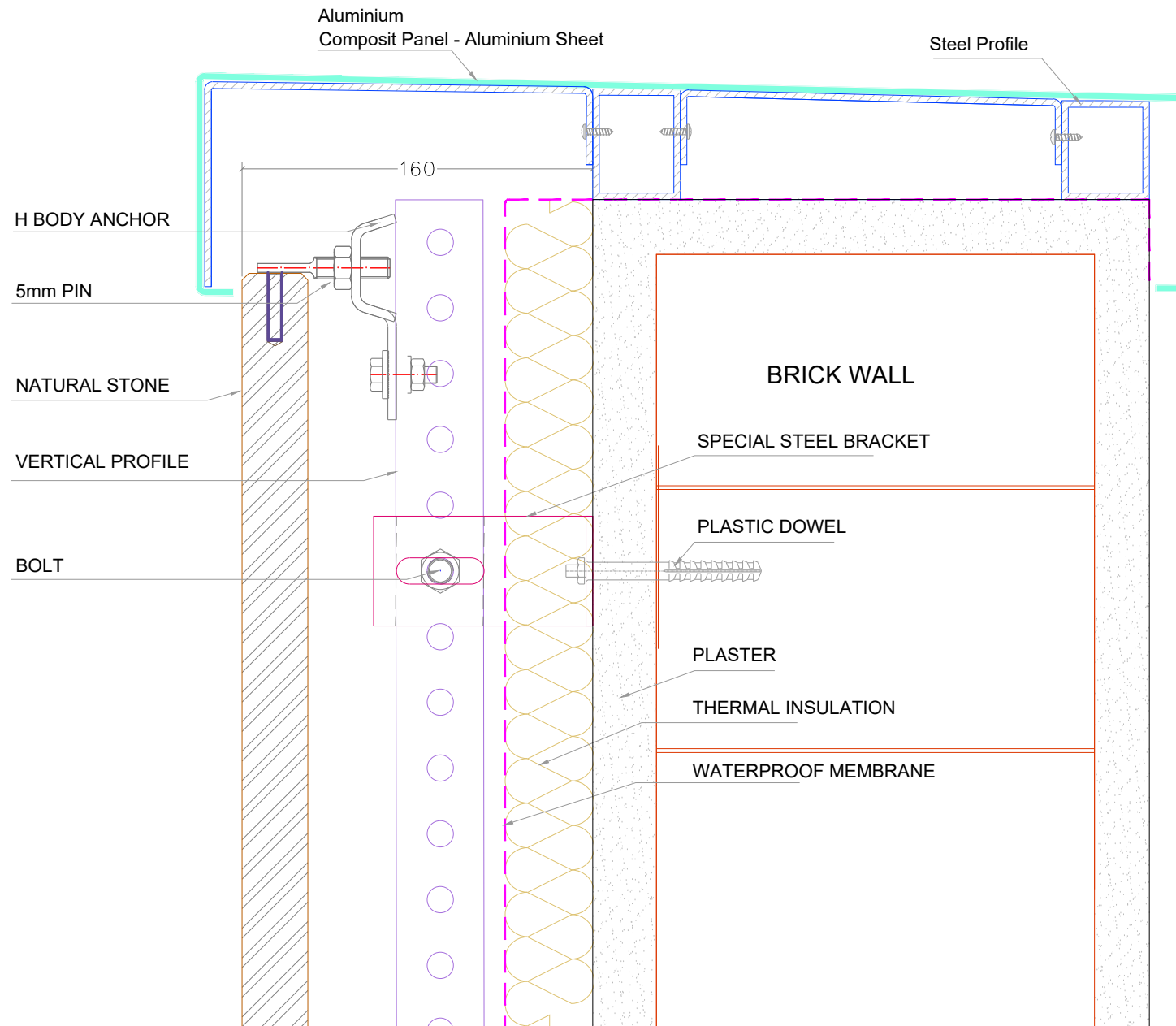

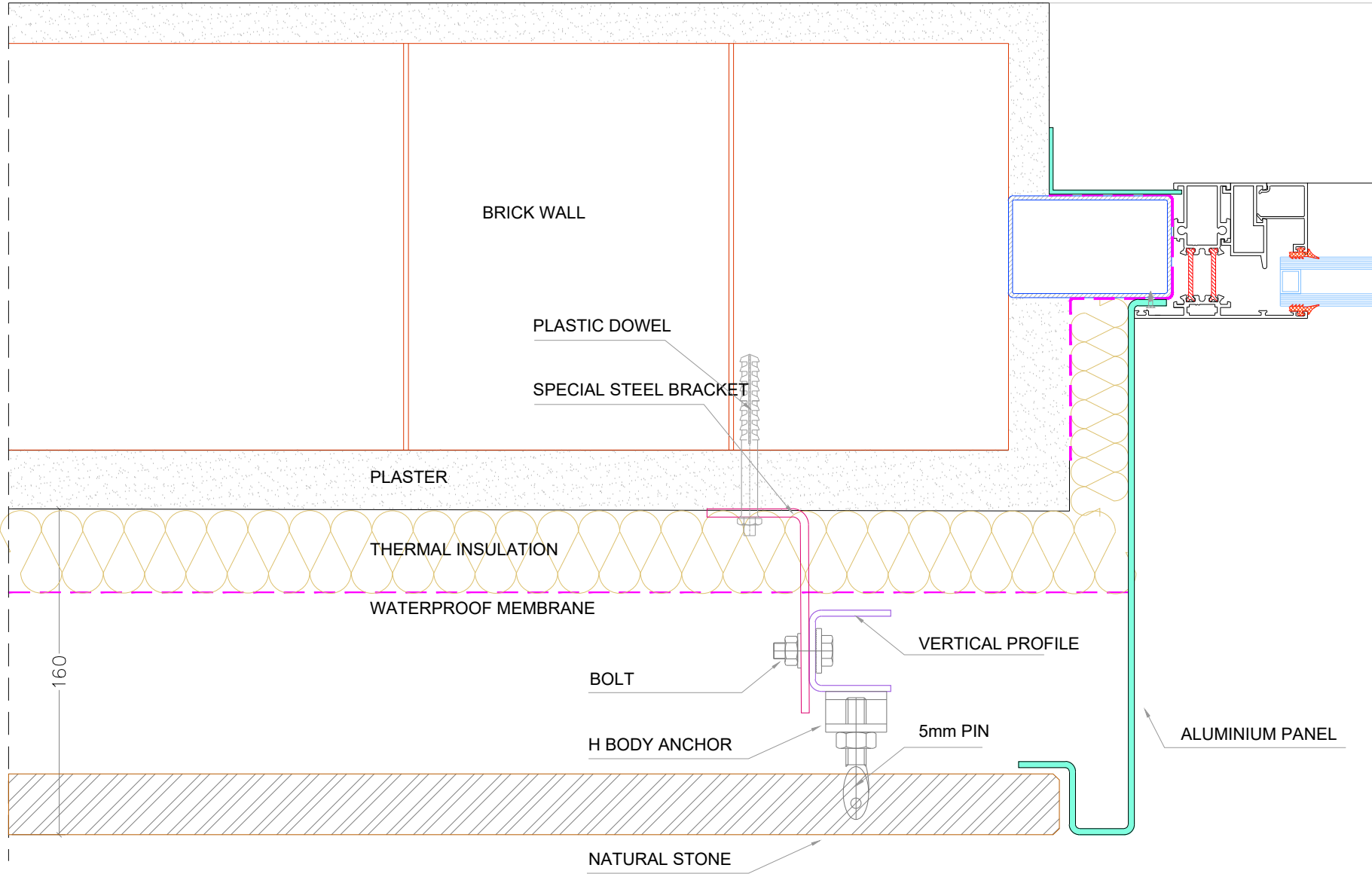

DETAIL 7

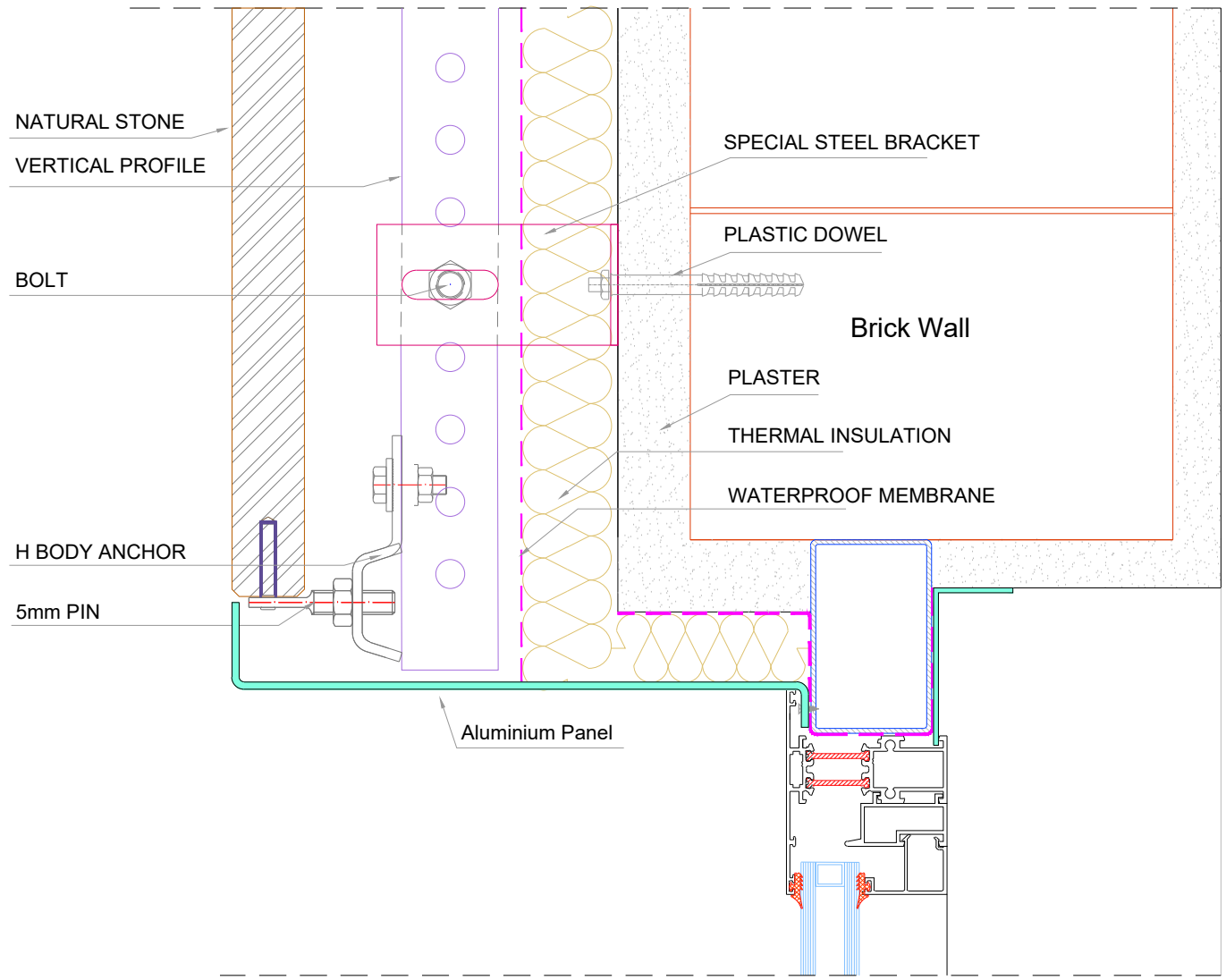

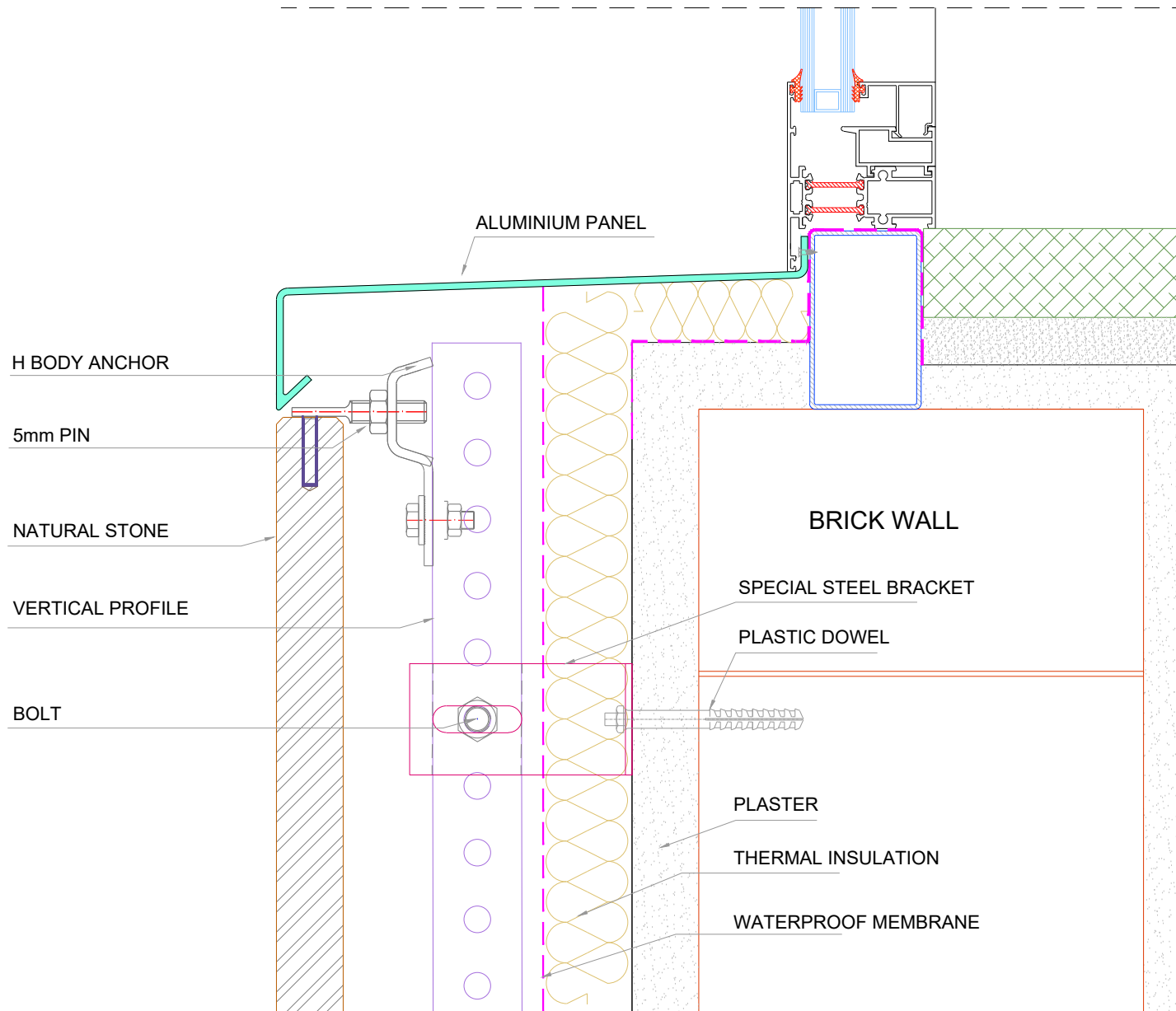

DETAIL 9

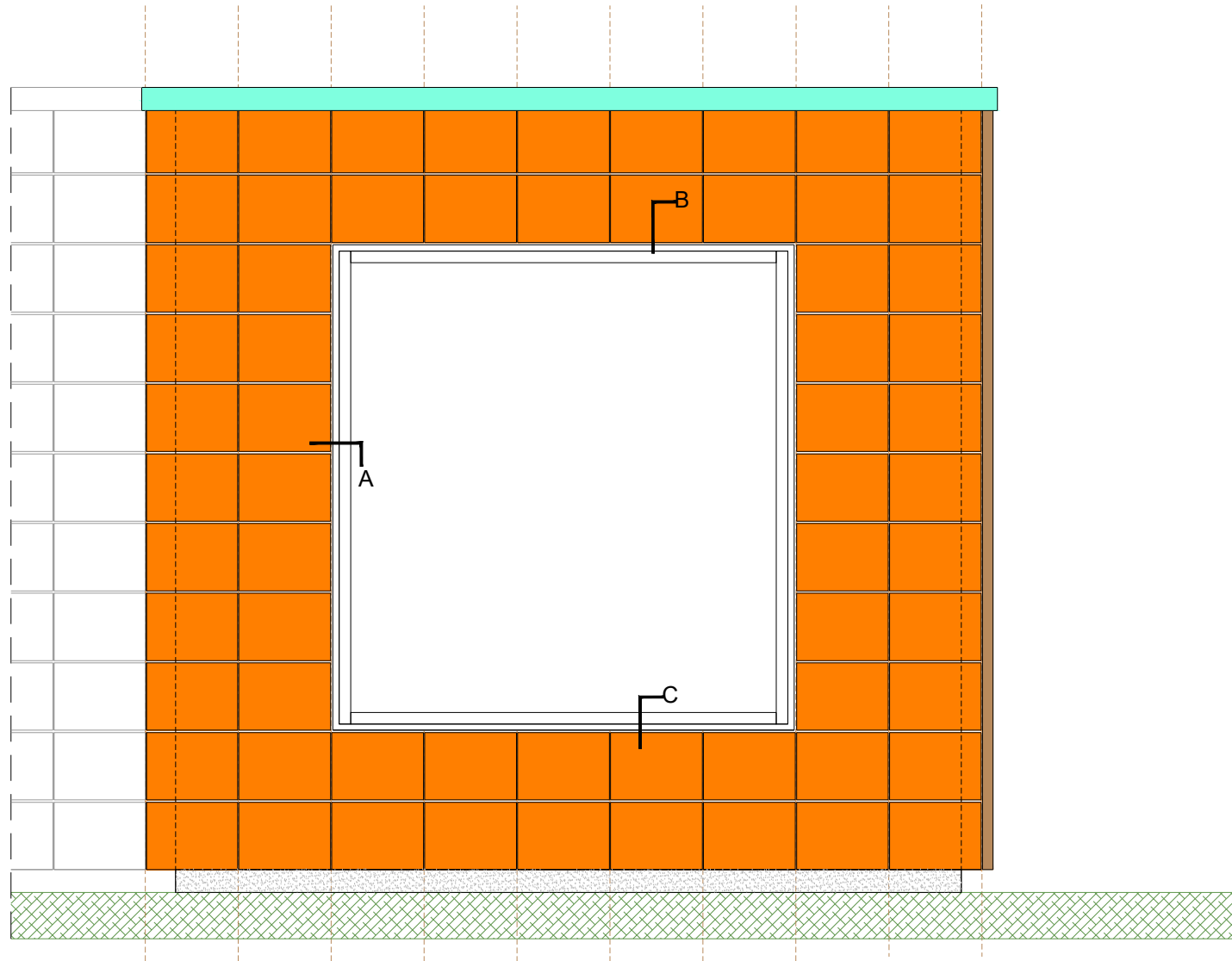

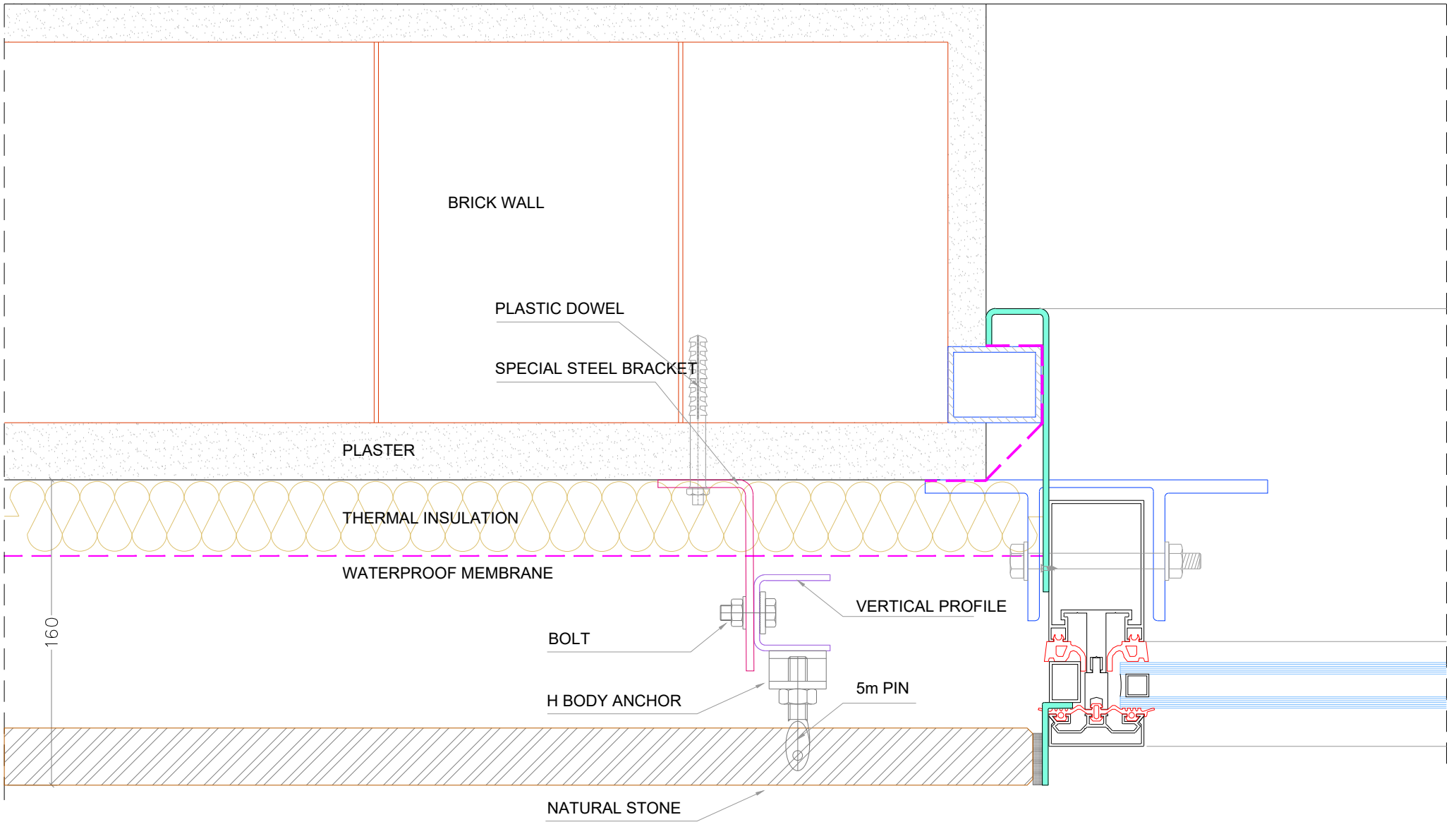

DETAIL A

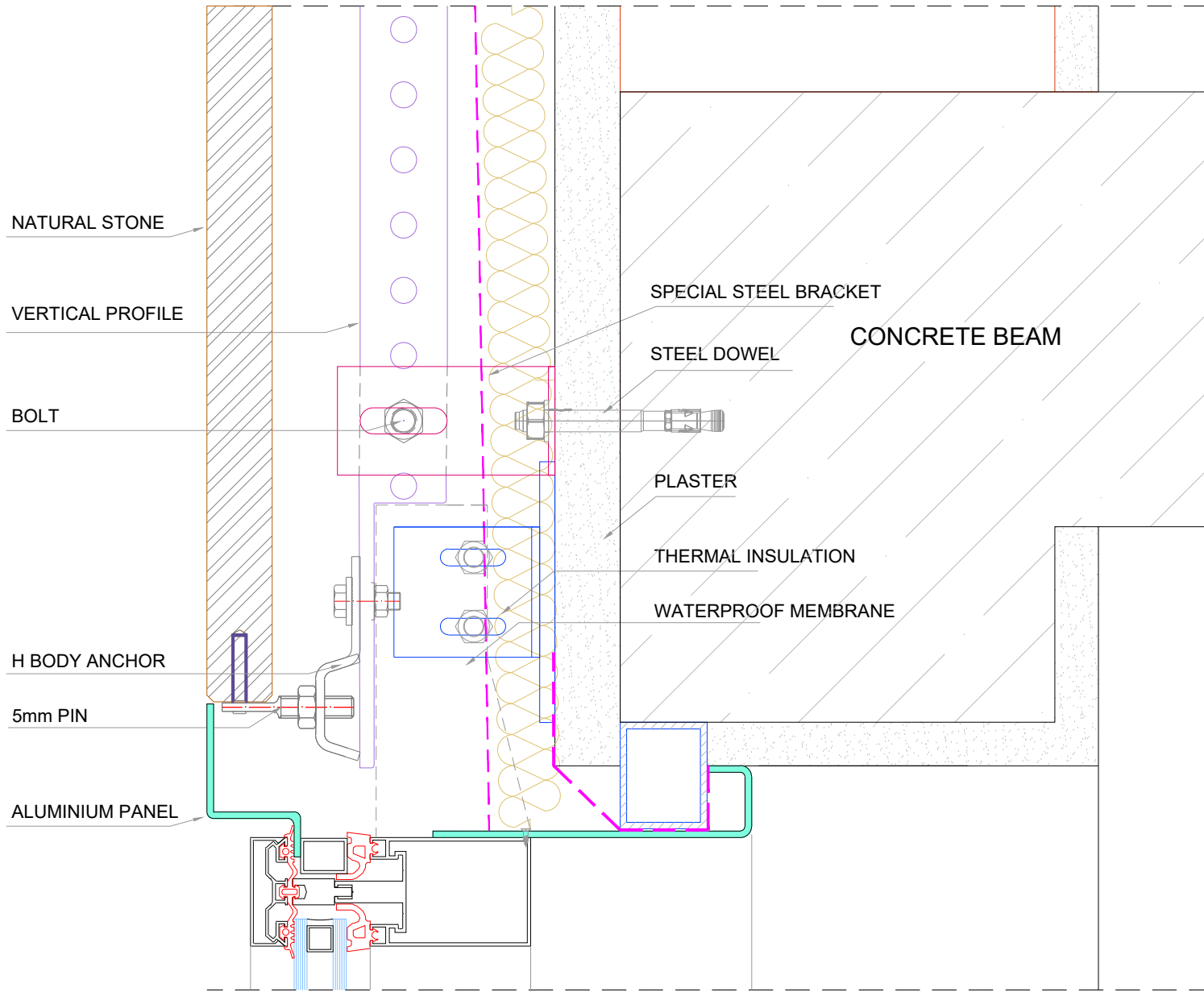

DETAIL B

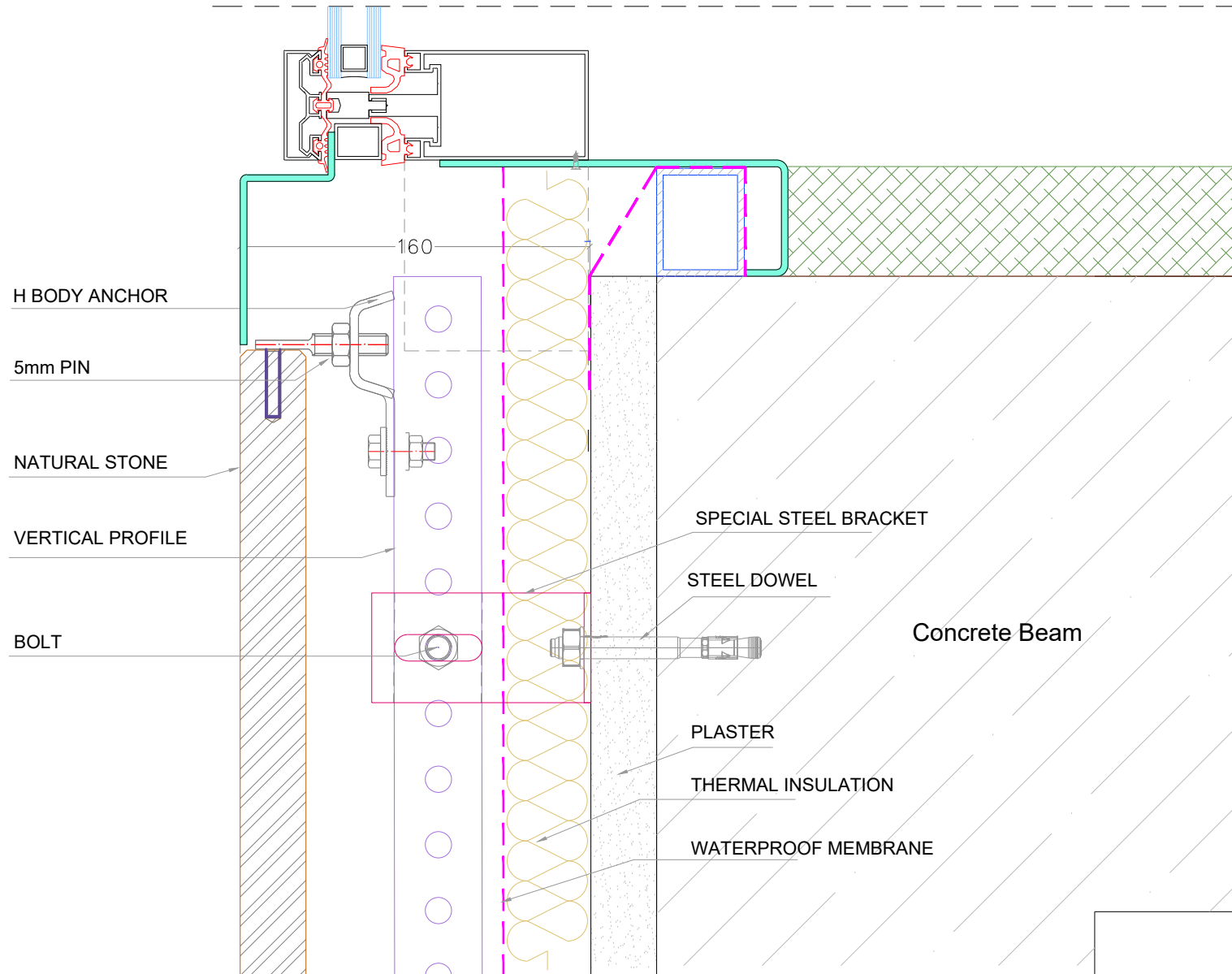

DETAIL C